

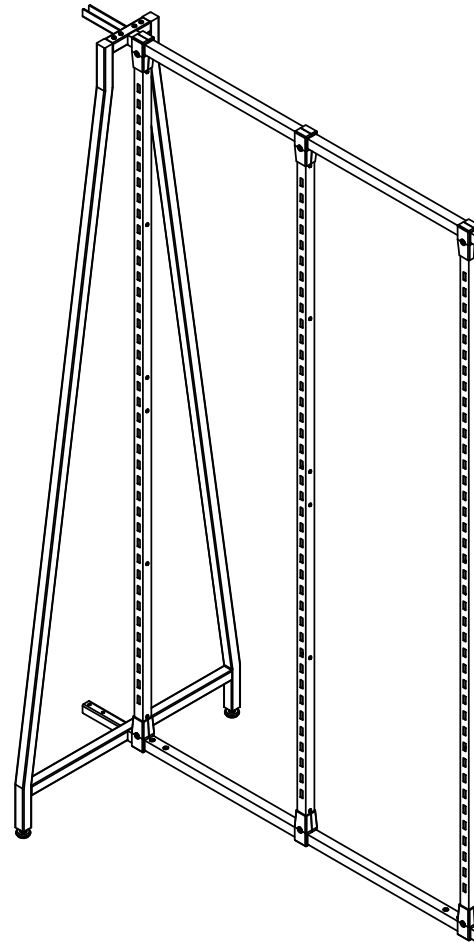

BURNSIDE

ASSEMBLY INSTRUCTIONS

D-FRAME - ADDON :: 292/299 - DF - ADD



PART LIST:



2X. UPRIGHT
- END



2X. SIDE
UPRIGHT



1X. CENTER
UPRIGHT

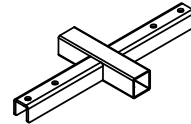

1X. TOP RAIL
- ADD

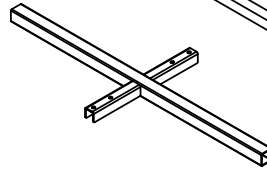

1X. BOTTOM RAIL
- ADD

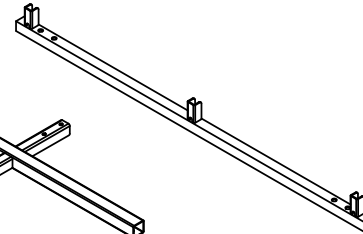

2X. RAIL

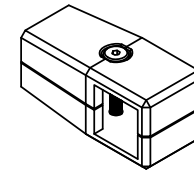

6X. CONNECTOR

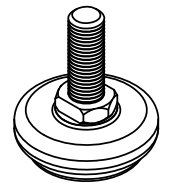

2X. 3/8"-16TPI LEVELER

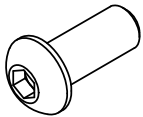

8X.SBHC SCREW
1/4"-20 X 0.625"

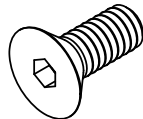

8X. SOCKET
COUNTERSUNK
HEAD SCREW
1/4"-20 X 0.625"

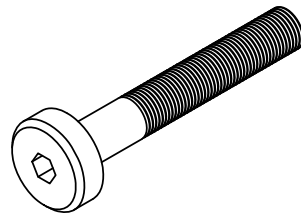

6X. JOINT CONNECTOR
BOLT 1/4"-20 X 1 5/8"



6X. HEX NUT
1/4"-20 TPI

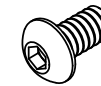

24X.SBHC SCREW
#10-24 X 0.375"

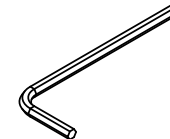

1X. L - KEY
FOR 1/4-20

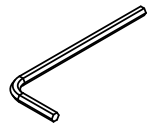

1X. L - KEY FOR
#10

STEP 1:

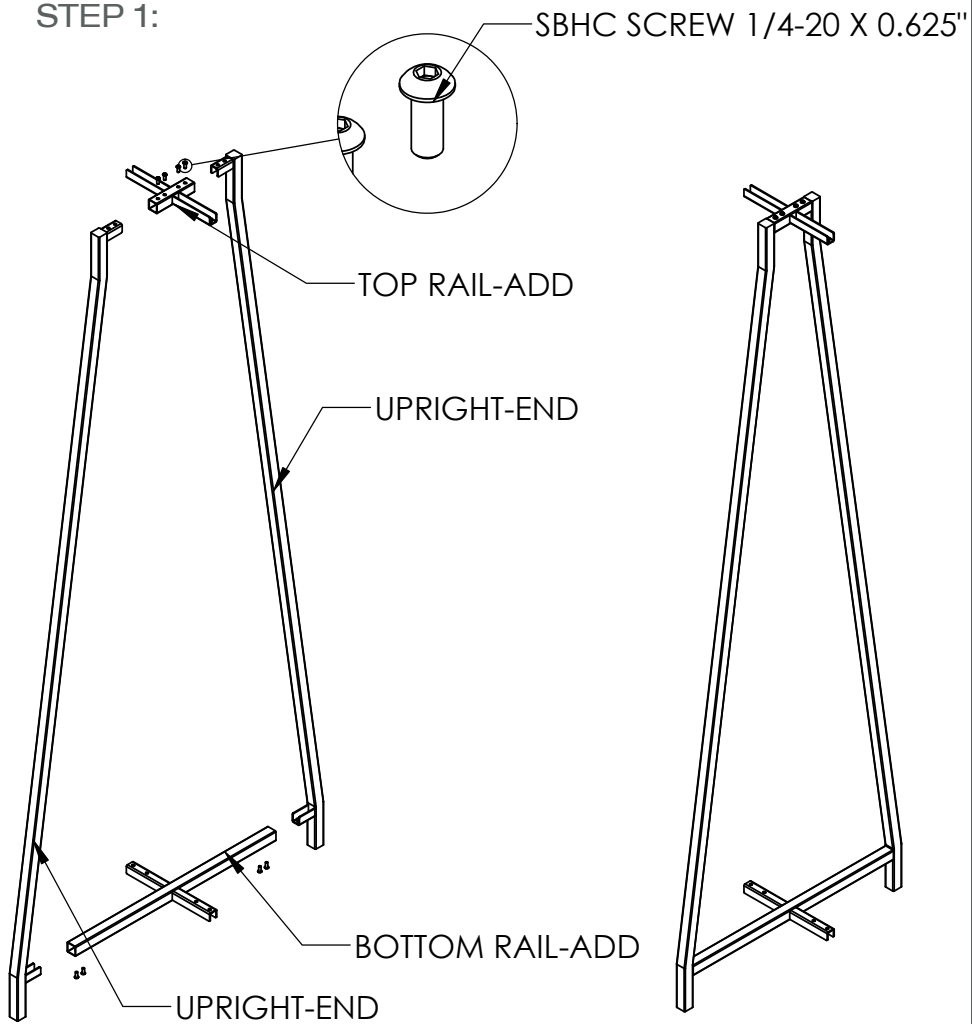

STEP 2:

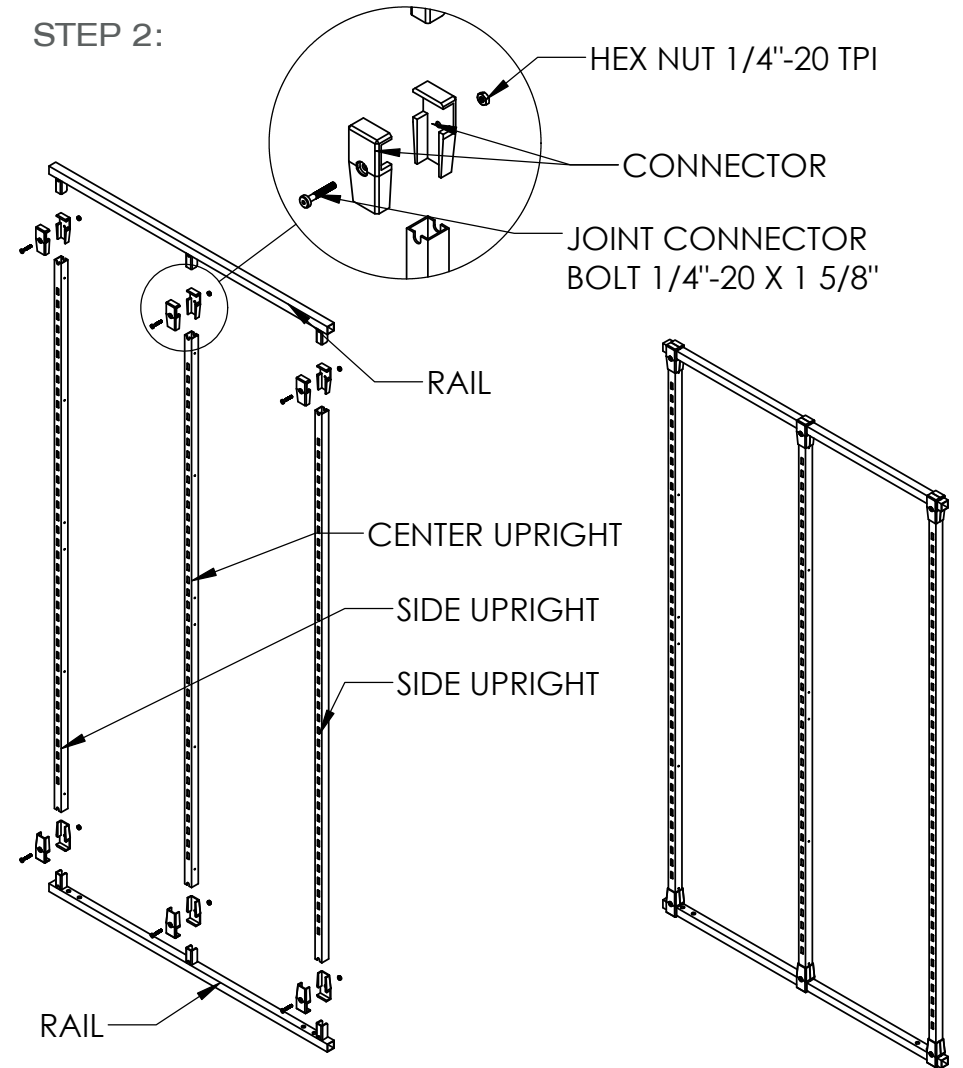

STEP 3:

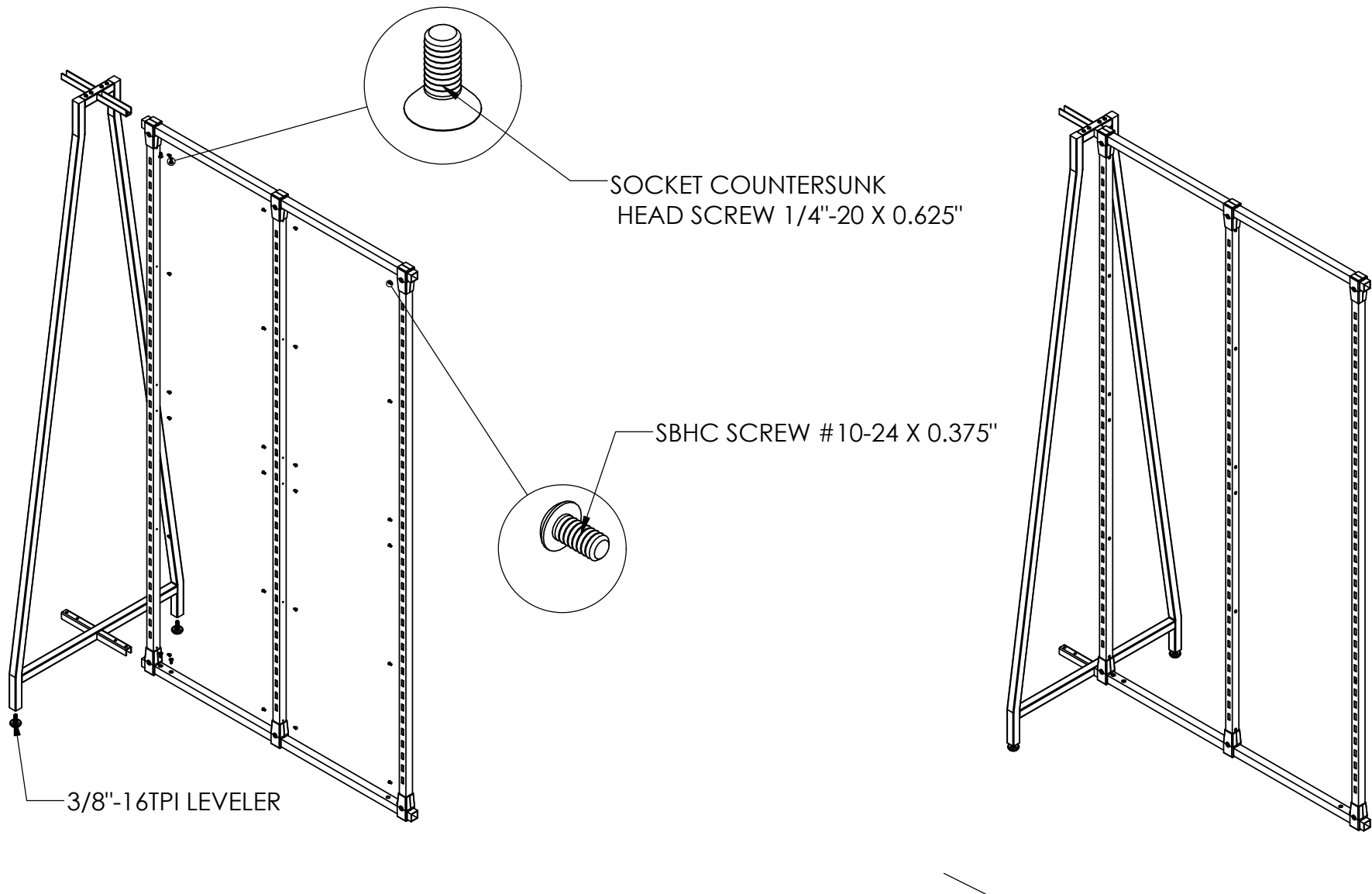

STEP 4:

